



# BCG13-N1BM0599

EcoLine

WIRE DRAW ENCODERS

**SICK**  
Sensor Intelligence.



Illustration may differ



### Ordering information

| Type           | Part no. |
|----------------|----------|
| BCG13-N1BM0599 | 1061036  |

**Included in delivery:** MRA-G130-105D3 (1), AFM60A-S1NB018x12 (1)

Product is supplied fully assembled. See individual components for further technical data

Other models and accessories → [www.sick.com/EcoLine](http://www.sick.com/EcoLine)

### Detailed technical data

#### Performance

BCG

|   |                           |
|---|---------------------------|
| <b>Measurement range</b>                | 0 m ... 5 m               |
| <b>Encoder</b>                          | Absolute encoders         |
| <b>Resolution (wire draw + encoder)</b> | 0.001 mm <sup>1) 2)</sup> |
| <b>Repeatability</b>                    | ≤ 0.2 mm <sup>3)</sup>    |
| <b>Linearity</b>                        | ≤ ± 2 mm <sup>3)</sup>    |
| <b>Hysteresis</b>                       | ≤ 0.4 mm <sup>3)</sup>    |

<sup>1)</sup> The values shown have been rounded.

<sup>2)</sup> Example calculation based on the BCG08 with PROFINET: 230 mm (wire draw length per revolution - see Mechanical data): 262,144 (number of steps per revolution) = 0.001 mm (resolution of wire draw + encoder combination).

<sup>3)</sup> Value applies to wire draw mechanism.

#### Interfaces

BCG

|                                  |          |
|----------------------------------|----------|
| <b>Communication interface</b>   | PROFINET |
| <b>Programmable/configurable</b> | ✓        |

#### Electrical data

BCG

|  |  |
|--|--|
| <b>Connection type</b>                       | Male connector, 1x, M12, 4-pin, axial<br>Female connector, 2x, M12, 4-pin, axial |
| <b>Supply voltage</b>                        | 10 V DC ... 30 V DC  |
| <b>Power consumption</b>                     | ≤ 3 W (without load)   |
| <b>MTTFd: mean time to dangerous failure</b> | 80 years (EN ISO 13849-1) <sup>1)</sup>  |

<sup>1)</sup> This product is a standard product and does not constitute a safety component as defined in the Machinery Directive. Calculation based on nominal load of components, average ambient temperature 40 °C, frequency of use 8760 h/a. All electronic failures are considered hazardous. For more information, see document no. 8015532.

## Mechanical data

BCG

|   |   |
|---|---|
| <b>Weight</b>                                   | 1 kg  |
| <b>Measuring wire material</b>                  | Highly flexible stranded steel 1,4401 stainless steel V4A |
| <b>Weight (measuring wire)</b>                  | 1.2 g/m   |
| <b>Housing material, wire draw mechanism</b>    | Plastic, Noryl  |
| <b>Spring return force</b>                      | 4.5 N ... 7 N <sup>1)</sup>                               |
| <b>Length of wire pulled out per revolution</b> | 385 mm  |
| <b>Life of wire draw mechanism</b>              | Typ. 1,000,000 cycles <sup>2) 3)</sup>                    |
| <b>Actual wire draw length</b>                  | 5.2 m   |
| <b>Wire acceleration</b>                        | 4 m/s <sup>2</sup>  |
| <b>Operating speed</b>                          | 3 m/s   |
| <b>Mounted encoder</b>                          | AFM60 PROFINET, AFM60A-S1NB018x12, 1059040                |
| <b>Mounted mechanic</b>                         | MRA-G130-105D3, 5322779                                   |

<sup>1)</sup> These values were measured at an ambient temperature of 25 °C. There may be variations at other temperatures.

<sup>2)</sup> Average values, which depend on the application.

<sup>3)</sup> The service life depends on the type of load. This is influenced by environmental conditions, the installation location, the measuring range in use, the traversing speed, and acceleration.

## Ambient data

BCG

|                                    |  |
|------------------------------------|--|
| <b>EMC</b>                         | According to EN 61000-6-2 and EN 61000-6-3 <sup>1)</sup> |
| <b>Enclosure rating</b>            | IP50   |
| <b>Operating temperature range</b> | -30 °C ... +70 °C  |

<sup>1)</sup> EMC according to the standards quoted is achieved if shielded cables are used.

## Classifications

|                       |          |
|-----------------------|----------|
| <b>ECl@ss 5.0</b>     | 27270590 |
| <b>ECl@ss 5.1.4</b>   | 27270590 |
| <b>ECl@ss 6.0</b>     | 27270590 |
| <b>ECl@ss 6.2</b>     | 27270590 |
| <b>ECl@ss 7.0</b>     | 27270590 |
| <b>ECl@ss 8.0</b>     | 27270590 |
| <b>ECl@ss 8.1</b>     | 27270590 |
| <b>ECl@ss 9.0</b>     | 27270590 |
| <b>ECl@ss 10.0</b>    | 27270613 |
| <b>ECl@ss 11.0</b>    | 27270503 |
| <b>ECl@ss 12.0</b>    | 27270503 |
| <b>ETIM 5.0</b>       | EC001486 |
| <b>ETIM 6.0</b>       | EC001486 |
| <b>ETIM 7.0</b>       | EC001486 |
| <b>ETIM 8.0</b>       | EC001486 |
| <b>UNSPSC 16.0901</b> | 41112113 |

### Dimensional drawing (Dimensions in mm (inch))

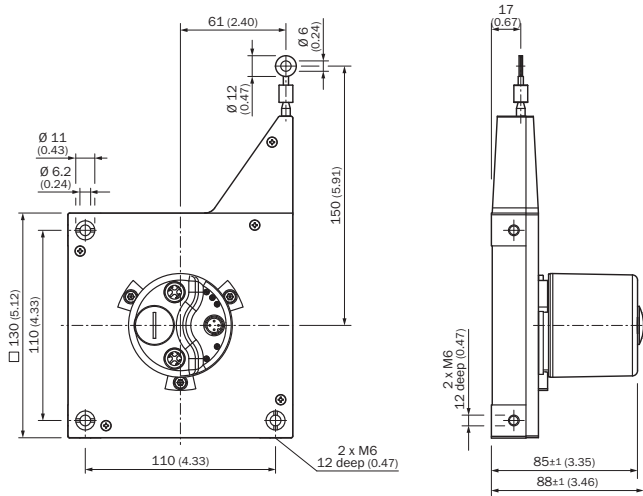

### PIN assignment

Male connector

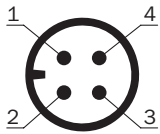

Supply voltage

| PIN | Wire color | Signal                       |
|-----|------------|------------------------------|
| 1   | Brown      | U <sub>S</sub> 10 V ... 30 V |
| 2   | White      | Not assigned                 |
| 3   | Blue       | GND                          |
| 4   | Black      | Not assigned                 |

Female connector

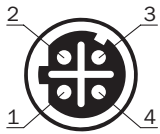

Port 1, Port 2



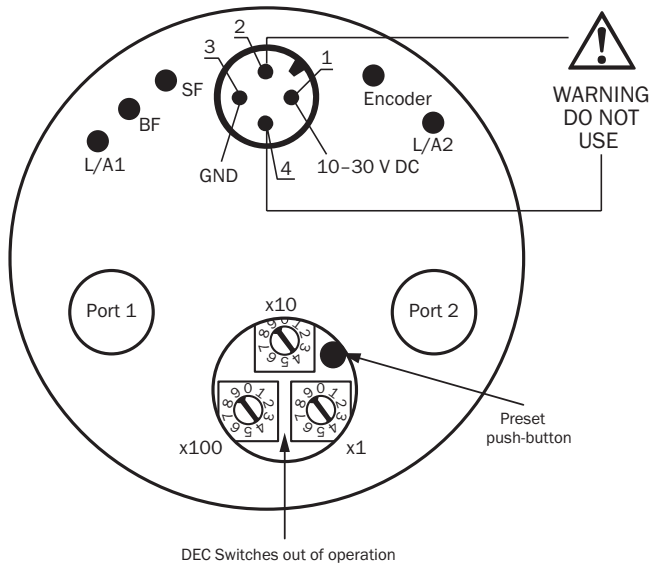

| PIN | Wire color | Signal |
|-----|------------|--------|
| 1   | Yellow     | T x D+ |
| 2   | White      | R x D+ |
| 3   | Orange     | T x D- |
| 4   | Blue       | R x D- |

Connection diagram



Recommended accessories

Other models and accessories → [www.sick.com/EcoLine](http://www.sick.com/EcoLine)

|   | Brief description   | Type               | Part no. |
|---|---|--------------------|----------|
| <b>Flanges</b>  |   |                    |          |
|  | Flange adapter for EcoLine wire draw mechanisms, adaption of face mount flange with centering hub 20 mm to 50 mm servo flange, Aluminum, including 3 countersunk screws M4 x 10 | BEF-FA-020-050-007 | 2073774  |
| <b>Plug connectors and cables</b>   |   |                    |          |
|  | Head A: male connector, M12, 4-pin, straight, D-coded<br>Head B: Flying leads<br>Cable: PROFINET, PVC, shielded, 2 m  | STL-1204-G02MZ90   | 6048247  |
|   | Head A: male connector, M12, 4-pin, straight, D-coded<br>Head B: Flying leads<br>Cable: PROFINET, PVC, shielded, 5 m  | STL-1204-G05MZ90   | 6048248  |
|   | Head A: male connector, M12, 4-pin, straight, D-coded<br>Head B: Flying leads<br>Cable: PROFINET, PVC, shielded, 10 m   | STL-1204-G10MZ90   | 6048249  |
|  | Head A: male connector, M12, 4-pin, angled, D-coded<br>Head B: Flying leads<br>Cable: PROFINET, PVC, shielded, 5 m  | STL-1204-W05MZ90   | 6048257  |
|   | Head A: male connector, M12, 4-pin, angled, D-coded<br>Head B: Flying leads<br>Cable: PROFINET, PVC, shielded, 25 m   | STL-1204-W25MZ90   | 6048259  |
|  | Head A: female connector, M12, 4-pin, straight, A-coded<br>Head B: Flying leads<br>Cable: Sensor/actuator cable, PUR, halogen-free, unshielded, 2 m                             | YF2A14-020UB3XLEAX | 2095607  |
|   | Head A: female connector, M12, 4-pin, straight, A-coded<br>Head B: Flying leads<br>Cable: Sensor/actuator cable, PUR, halogen-free, unshielded, 5 m                             | YF2A14-050UB3XLEAX | 2095608  |

|   | Brief description   | Type                                       | Part no. |
|---|---|--|----------|
|   | Head A: female connector, M12, 4-pin, straight, A-coded<br>Head B: Flying leads<br>Cable: Sensor/actuator cable, PUR, halogen-free, unshielded, 10 m                        | YF2A14-100UB3XLEAX                         | 2095609  |
|   | Head A: female connector, M12, 4-pin, straight, A-coded<br>Head B: Flying leads<br>Cable: Sensor/actuator cable, PUR, halogen-free, unshielded, 25 m                        | YF2A14-250UB3XLEAX                         | 2095615  |
|    | Head A: female connector, M12, 4-pin, angled, A-coded<br>Head B: Flying leads<br>Cable: Sensor/actuator cable, PUR, halogen-free, unshielded, 2 m                           | YG2A14-020UB3XLEAX                         | 2095766  |
|   | Head A: female connector, M12, 4-pin, angled, A-coded<br>Head B: Flying leads<br>Cable: Sensor/actuator cable, PUR, halogen-free, unshielded, 5 m                           | YG2A14-050UB3XLEAX                         | 2095767  |
|   | Head A: female connector, M12, 4-pin, angled, A-coded<br>Head B: Flying leads<br>Cable: Sensor/actuator cable, PUR, halogen-free, unshielded, 10 m                          | YG2A14-100UB3XLEAX                         | 2095768  |
|   | Head A: female connector, M12, 4-pin, angled, A-coded<br>Head B: Flying leads<br>Cable: Sensor/actuator cable, PUR, halogen-free, unshielded, 25 m                          | YG2A14-250UB3XLEAX                         | 2095771  |
|    | Head A: male connector, M12, 4-pin, angled, D-coded<br>Head B: male connector, M12, 4-pin, angled, D-coded<br>Cable: PROFINET, PUR, halogen-free, shielded, 2 m             | SSL-1204-W02MZ                             | 6050635  |
|   | Head A: male connector, M12, 4-pin, angled, D-coded<br>Head B: male connector, M12, 4-pin, angled, D-coded<br>Cable: PROFINET, PUR, halogen-free, shielded, 5 m             | SSL-1204-W05MZ                             | 6050636  |
|   | Head A: male connector, M12, 4-pin, angled, D-coded<br>Head B: male connector, M12, 4-pin, angled, D-coded<br>Cable: PROFINET, EtherCAT®, PUR, halogen-free, shielded, 10 m | SSL-1204-W10MZ                             | 6050637  |
|  | Head A: male connector, RJ45, 4-pin, straight<br>Head B: male connector, M12, 4-pin, angled, D-coded<br>Cable: PROFINET, EtherCAT®, PVC, shielded, 2 m                      | SSL-2J04-F02MZ                             | 6048253  |
|   | Head A: male connector, RJ45, 4-pin, straight<br>Head B: male connector, M12, 4-pin, angled, D-coded<br>Cable: PROFINET, EtherCAT®, PVC, shielded, 5 m                      | SSL-2J04-F05MZ                             | 6048254  |
|   | Head A: male connector, RJ45, 4-pin, straight<br>Head B: male connector, M12, 4-pin, angled, D-coded<br>Cable: PROFINET, EtherCAT®, PVC, shielded, 10 m                     | SSL-2J04-F10MZ                             | 6048255  |
|   | Head A: male connector, RJ45, 4-pin, straight<br>Head B: male connector, M12, 4-pin, angled, D-coded<br>Cable: PROFINET, EtherCAT®, PVC, shielded, 30 m                     | SSL-2J04-F30MZ                             | 6059450  |
|  | Head A: female connector, M12, 4-pin, angled<br>Cable: unshielded   | DOS-1204-W                                 | 6007303  |
|  | Head A: male connector, M12, 4-pin, angled, D-coded<br>Cable: PROFINET, shielded  | STE-1204-WZ                                | 6048262  |
|  | Head A: female connector, M12, 4-pin, D-coded<br>Head B: female connector, RJ45, 8-pin<br>Cable: Ethernet, shielded<br>Cabinet through                                      | Feedthrough female connector Ethernet RJ45 | 6048180  |

## SICK AT A GLANCE

SICK is one of the leading manufacturers of intelligent sensors and sensor solutions for industrial applications. A unique range of products and services creates the perfect basis for controlling processes securely and efficiently, protecting individuals from accidents and preventing damage to the environment.

We have extensive experience in a wide range of industries and understand their processes and requirements. With intelligent sensors, we can deliver exactly what our customers need. In application centers in Europe, Asia and North America, system solutions are tested and optimized in accordance with customer specifications. All this makes us a reliable supplier and development partner.

Comprehensive services complete our offering: SICK LifeTime Services provide support throughout the machine life cycle and ensure safety and productivity.

For us, that is “Sensor Intelligence.”

## WORLDWIDE PRESENCE:

Contacts and other locations –[www.sick.com](http://www.sick.com)