



5-year warranty



MFT

Technical data

Electrical data	Nominal voltage	AC/DC 24 V
	Nominal voltage frequency	50/60 Hz
	Nominal voltage range	AC 19.2...28.8 V / DC 21.6...28.8 V
	Power consumption in operation	2.5 W
	Power consumption in rest position	1 W
	Transformer sizing	4 VA
	Auxiliary switch	1 x SPDT, 3 A resistive (0.5 A inductive) @ AC 250 V, adjustable 0...95°
	Switching capacity auxiliary switch	3 A resistive (0.5 A inductive) @ AC 250 V
	Electrical Connection	(2) 18 GA appliance cables, 1 m, 3 m or 5 m, with or without 1/2" conduit connectors
	Overload Protection	electronic throughout 0...95° rotation
Electrical Protection	actuators are double insulated	
Functional data	Torque motor	22 in-lb [2.5 Nm]
	Operating range Y	2...10 V
	Operating range Y note	4...20 mA w/ ZG-R01 (500 Ω, 1/4 W resistor)
	Input Impedance	100 kΩ for 2...10 V (0.1 mA), 500 Ω for 4...20 mA, 1500 Ω for PWM, On/Off and Floating point
	Operating range Y variable	Start point 0.5...30 V End point 2.5...32 V
	Operating modes optional	variable (VDC, PWM, on/off, floating point)
	Position feedback U	2...10 V
	Position feedback U note	Max. 0.5 mA
	Position feedback U variable	VDC variable
	Direction of motion motor	selectable with switch 0/1
	Direction of motion fail-safe	reversible with cw/ccw mounting
	Angle of rotation	Max. 95°
	Angle of rotation note	adjustable with mechanical stop
	Running Time (Motor)	150 s /
	Running time motor variable	75...300 s
	Running time fail-safe	<25 s @ -4...122°F [-20...50°C], <60 s @ -22°F [-30°C]
	Adaptation Setting Range	off (default)
	Override control	MIN (minimum position) = 0% MID (intermediate position) = 50% MAX (maximum position) = 100%
	Noise level, motor	35 dB(A)
	Noise level, fail-safe	62 dB(A)
Position indication	Mechanical	
Safety data	Power source UL	Class 2 Supply

Safety data	Degree of protection IEC/EN	IP42
	Degree of protection NEMA/UL	NEMA 2
	Enclosure	UL Enclosure Type 2
	Agency Listing	cULus acc. to UL60730-1A/-2-14, CAN/CSA E60730-1:02 CE acc. to 2014/30/EU and 2014/35/EU
	Quality Standard	ISO 9001
	UL 2043 Compliant	Suitable for use in air plenums per Section 300.22(C) of the NEC and Section 602 of the IMC
	Ambient humidity	Max. 95% RH, non-condensing
	Ambient temperature	-22...122°F [-30...50°C]
	Storage temperature	-40...176°F [-40...80°C]
	Servicing	maintenance-free
Weight	Weight	1.0 lb [0.44 kg]
Materials	Housing material	UL94-5VA

Footnotes *Variable when configured with MFT options.
†Rated Impulse Voltage 800V, Type of Action 1.AA.B, Control Pollution Degree 3.

Product features

- Default/Configuration** Default parameters for DC 2...10 V applications of the TF.-MFT actuator are assigned during manufacturing. If required, custom versions of the actuator can be ordered. The parameters are variable and can be changed by three means: factory pre-set, custom configuration (set by the customer using PC-Tool software) or the handheld ZTH US.
- Application** For fail-safe, modulating control of dampers in HVAC systems. Actuator sizing should be done in accordance with the damper manufacturer's specifications. A feedback signal is provided for position indication.
- Operation** The TF series actuators provide true spring return operation for reliable fail-safe application and positive close-off on air tight dampers. The spring return system provides consistent torque to the damper with, and without, power applied to the actuator. The TF series provides 95° of rotation and is provided with a graduated position indicator showing 0 to 95°. The TF uses a brushless DC motor which is controlled by an Application Specific Integrated Circuit (ASIC) and a microprocessor. The microprocessor provides the intelligence to the ASIC to provide a constant rotation rate and to know the actuator's exact fail-safe position. The ASIC monitors and controls the brushless DC motor's rotation and provides a digital rotation sensing function to prevent damage to the actuator in a stall condition. The actuator may be stalled anywhere in its normal rotation without the need of mechanical end switches. Power consumption is reduced in holding mode. The TF -S versions are provided with one built-in auxiliary switch. This SPDT switch is provided for safety interfacing or signaling, for example, for fan start-up. The switching function is adjustable between 0° and 95°.
- Safety Note: Screw a conduit fitting into the actuator's bushing. Jacket the actuator's input and output wiring with suitable flexible conduit. Properly terminate the conduit in a suitable junction box.

Typical specification Spring return control damper actuators shall be direct coupled type which require no crank arm and linkage and be capable of direct mounting to a shaft up to a 1/2" diameter and center on a 1/2" shaft. The actuator must provide modulating damper control in response to a 2 to 10 VDC or, with the addition of a 500Ω resistor, a 4 to 20 mA control input from an electronic controller or positioner. The actuator must be designed so that they may be used for either clockwise or counter clockwise fail-safe operation. Actuators shall use a brushless DC motor controlled by a microprocessor and be protected from overload at all angles of rotation. Run time shall be constant, and independent of torque. A 2 to 10 VDC feedback signal shall be provided for position feedback. If required, one SPDT auxiliary switch shall be provided having the capability of being adjustable. Actuators with auxiliary switch must be constructed to meet the requirements for Double Insulation so an electrical ground is not required to meet agency listings. Actuators shall be cULus listed, have a 5 year warranty, and be manufactured under ISO 9001 International Quality Control Standards. Actuators shall be as manufactured by Belimo.

Factory settings Default parameters for DC 2...10 V applications of the TF..-MFT actuator are assigned during manufacturing. If required, custom versions of the actuator can be ordered. The parameters are variable and can be changed by three means: factory pre-set, custom configuration (set by the customer using PC-Tool software) or the handheld ZTH US.

Accessories

Electrical accessories	Description	Type
	DC Voltage Input Rescaling Module	IRM-100
	Auxiliary switch, mercury-free	P475
	Auxiliary switch, mercury-free	P475-1
	Convert Pulse Width Modulated Signal to a 2...10 V Signal for Belimo Proportional Actuators	PTA-250
	Positioner for wall mounting	SGA24
	Positioner for front-panel mounting	SGF24
	Cable conduit connector 1/2"	TF-CC US
	Gateway MP to BACnet MS/TP	UK24BAC
	Gateway MP to LonWorks	UK24LON
	Gateway MP to Modbus RTU	UK24MOD
	Resistor, 500 Ω, 1/4" wire resistor with 6" pigtail wires	ZG-R01
	Resistor kit, 50% voltage divider	ZG-R02
	Transformer, AC 120 V to AC 24 V, 40 VA	ZG-X40

Mechanical accessories	Description	Type
	Shaft extension 170 mm Ø10 mm for damper shaft Ø 6...16 mm	AV6-20
	Position indicator for TFB(X)	IND-TF
	Shaft clamp for TFB(X)	K8 US
	Ball joint suitable for damper crank arm KH8 / KH10, Multipack 10 pcs.	KG10A
	Ball joint suitable for damper crank arm KH8, Multipack 10 pcs.	KG6
	Ball joint suitable for damper crank arm KH8, Multipack 10 pcs.	KG8
	Damper crank arm Slot width 8.2 mm, for Ø1.05"	KH12
	Damper crank arm Slot width 6.2 mm, clamping range Ø10...18 mm	KH6
	Damper crank arm Slot width 8.2 mm, clamping range Ø10...18 mm	KH8
	TFB(X) crankarm with 5/16" slot.	KH-TF US
	TFB(X) crankarm with 1/4" slot.	KH-TF-1 US
	Screw fastening kit	SB-TF
	Push rod for KG10A ball joint 36" L, 3/8" diameter	SH10
	Push rod for KG6 & KG8 ball joints (36" L, 5/16" diameter).	SH8
	Anti-rotation bracket TF/NKQ/AM/NM/LM.	TF-P
	Wrench 0.32 in and 0.39 in [8 mm and 10 mm]	TOOL-06
	Angle of rotation limiter, with end stop	ZDB-TF
	Mounting bracket for TFB(X)	ZG-113
	Damper clip for damper blade, 3.5" width.	ZG-DC1
	Damper clip for damper blade, 6" width.	ZG-DC2
	Shaft extension for 3/8" diameter shafts (4" L).	ZG-LMSA-1
	Shaft extension for 1/2" diameter shafts (5" L).	ZG-LMSA-1/2-5
	TFB(X) crankarm adaptor kit (includes ZG-113).	ZG-TF112
	TFB(X) crankarm adaptor kit (T bracket included).	ZG-TF2
	Mounting kit for TFB(X)	ZG-TF3
	Weather shield 330x203x152 mm [13x8x6"] (LxBxH)	ZS-100
	Base plate, for ZS-100	ZS-101
	Weather shield 406x213x102 mm [16x8-3/8x4"] (LxWxH)	ZS-150
Tools	Description	Type
	Belimo PC-Tool, Software for adjustments and diagnostics	MFT-P
	Signal simulator, Power supply AC 120 V	PS-100

Electrical installation

- ⚠ Warning! Live electrical components!**
During installation, testing, servicing and troubleshooting of this product, it may be necessary to work with live electrical components. Have a qualified licensed electrician or other individual who has been properly trained in handling live electrical components perform these tasks. Failure to follow all electrical safety precautions when exposed to live electrical components could result in death or serious injury.
- ◆ Meets cULus requirements without the need of an electrical ground connection.
 - ⚠ Apply only AC line voltage or only UL-Class 2 voltage to the terminals of auxiliary switches. Mixed or combined operation of line voltage/safety extra low voltage is not allowed.
 - Ⓐ Actuators with appliance cables are numbered.
 - 1 Provide overload protection and disconnect as required.
 - 3 Actuators may also be powered by DC 24 V.
 - 5 Only connect common to negative (-) leg of control circuits.
 - 7 A 500 Ω resistor (ZG-R01) converts the 4...20 mA control signal to 2...10 V.
 - 8 Control signal may be pulsed from either the Hot (Source) or Common (Sink) 24 V line.
 - 10 For triac sink the Common connection from the actuator must be connected to the Hot connection of the controller. Position feedback cannot be used with a triac sink controller; the actuator internal common reference is not compatible.
 - 11 Actuators may be connected in parallel if not mechanically linked. Power consumption and input impedance must be observed.
 - 12 IN4004 or IN4007 diode. (IN4007 supplied, Belimo part number 40155).
 - 44 One built-in auxiliary switch (1x SPDT), for end position indication, interlock control, fan startup, etc.

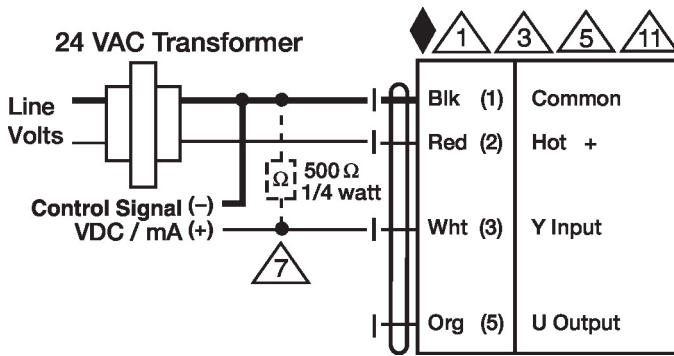

VDC/mA Control

Wiring diagrams

On/Off

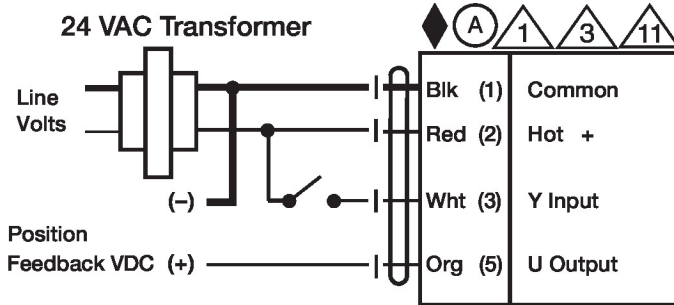

VDC/mA Control

Floating Point

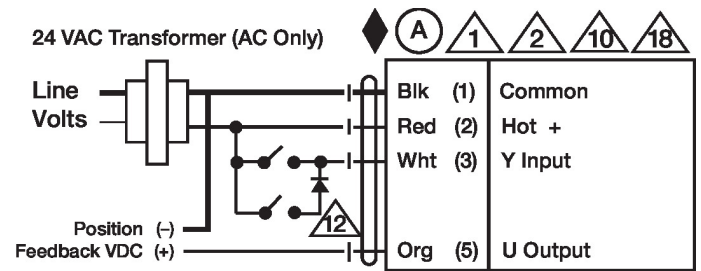

24 VAC Transformer

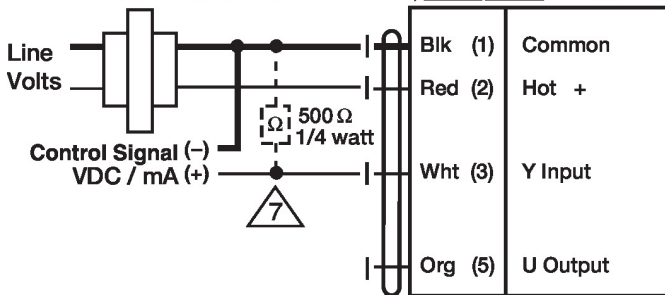

PWM Control

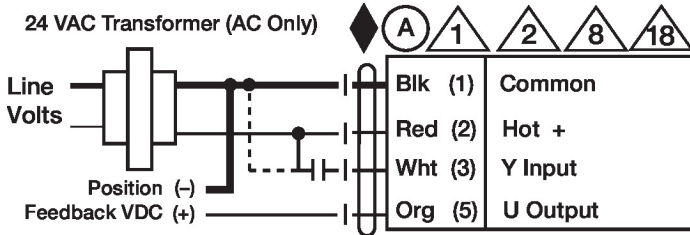

Override Control

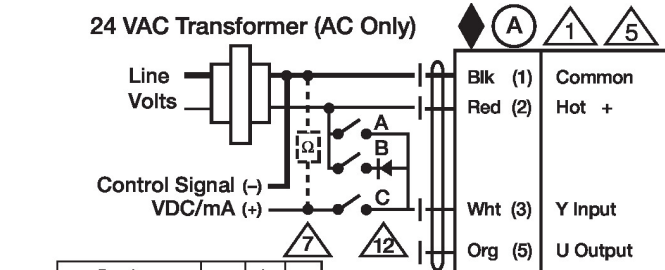

Functions	a	b	c
Min	0% ←	↗	↘
Mid	50% ←	↗	↘
Max	100% ←	↗	↘
Normal	Control mode acc. to Y	↗	↘

Auxiliary Switches

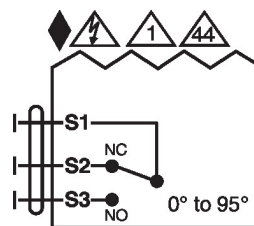

Dimensions

